

Single Phase EMI Filter – MF420HP

High Performance type

Description

These series range of High Performance filters are designed to suppress undesirable electrical disturbances In Power Lines. They limit the amplitude of interfering voltages on AC power lines and prevent them from propagating into or out of the filtered equipment.

Features

- Rated Current up to 50A
- Medical Version available
- High Conducted attenuation performance
- Chassis mounting

Applications

- Power Systems
- Electronic Equipment
- Frequency convertors
- Stepper motor drives
- UPS/Inverters

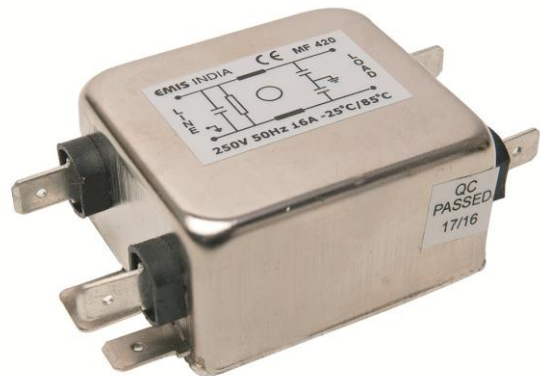

Approvals & Compliance



Typical circuit Diagram

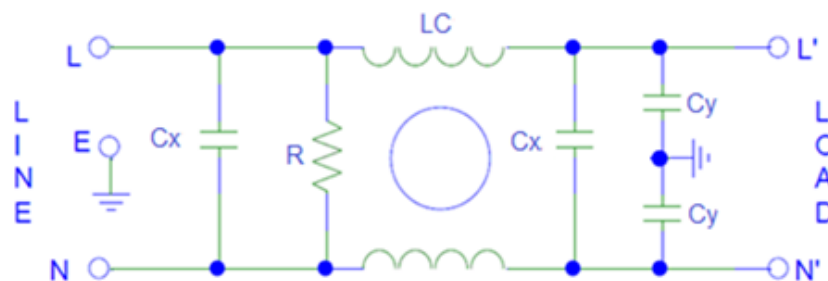



Technical Specifications

Maximum Continuous Operating Voltage	: 250VAC
Operating Frequency	: 50/60Hz
Current ratings	: 1A to 50A @40°C
High Potential test voltage	: L to G 2250Vdc for 1 Minute L to L 1450Vdc for 1 Minute
Overload Capability	: 135% of Rated current for 15 minutes
Design Corresponding to	: UL1283, CSA 22.2 No.8-13 and IEC 60939
Flammability corresponding to	: UL 94 V-0
Temperature range	: -25°C to +85°C
Climatic Category	: 25/85/21

Image shown above is just for reference

Selection Table

Part Number	Ordering Code	Rated Current @40°C	Leakage Current @250VAC/50Hz (mA)	Termination		Weight (Grams)
						
MF420HP - 01	S420HP0001S	1A	7.4	6.3x0.8		65
MF420HP - 02	S420HP0002S	2A	7.4	6.3x0.8		65
MF420HP - 03	S420HP0003S	3A	7.4	6.3x0.8		65
MF420HP - 05	S420HP0005S	5A	7.4	6.3x0.8		65
MF420HP - 06	S420HP0006S	6A	7.4	6.3x0.8		65
MF420HP - 10	S420HP0010S	10A	7.4	6.3x0.8		65
MF420HP - 12	S420HP0012N	12A	7.4		M5	300
MF420HP - 15	S420HP0015N	15A	7.4		M5	300
MF420HP - 16	S420HP0016N	16A	7.4		M5	300
MF420HP - 18	S420HP0018N	18A	7.4		M5	300
MF420HP - 20	S420HP0020N	20A	7.4		M5	300
MF420HP - 25	S420HP0025N	25A	7.4		M5	300
MF420HP - 30	S420HP0030N	30A	7.4		M5	600
MF420HP - 32	S420HP0032N	32A	7.4		M5	600
MF420HP - 35	S420HP0035N	35A	7.4		M5	600
MF420HP - 40	S420HP0040N	40A	7.4		M5	600
MF420HP - 42	S420HP0042N	42A	7.4		M6	800
MF420HP - 45	S420HP0045N	45A	7.4		M6	800
MF420HP - 47	S420HP0047N	47A	7.4		M6	800
MF420HP - 50	S420HP0050N	50A	7.4		M6	800

Note: Customized filters are provided on request.

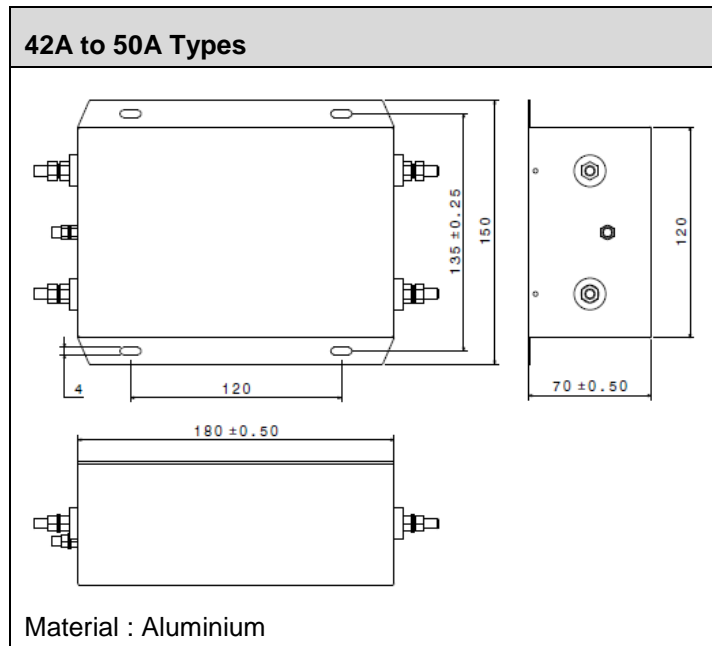
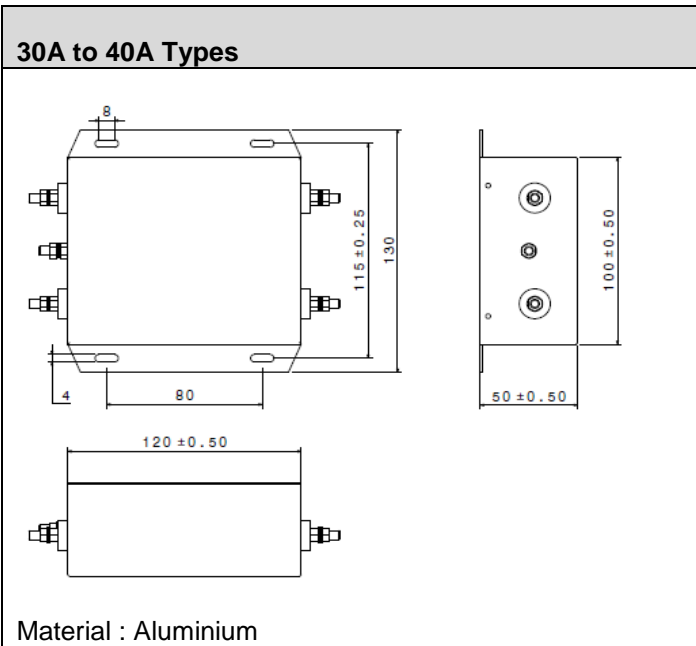
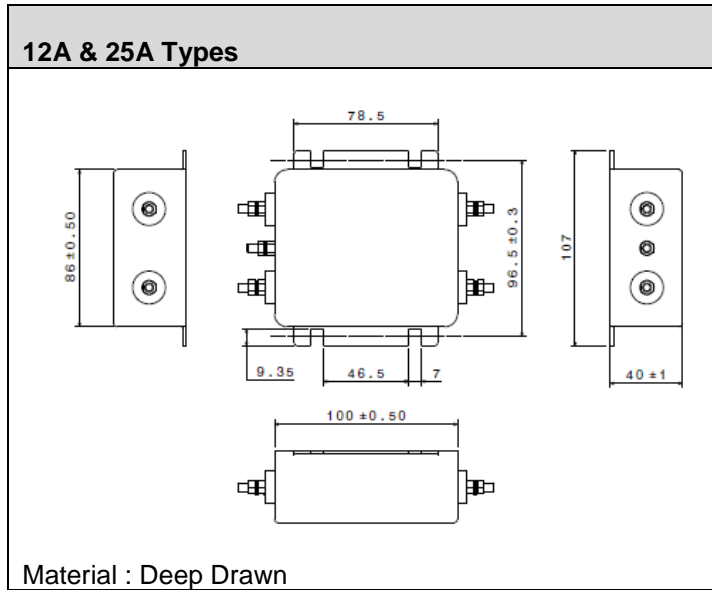
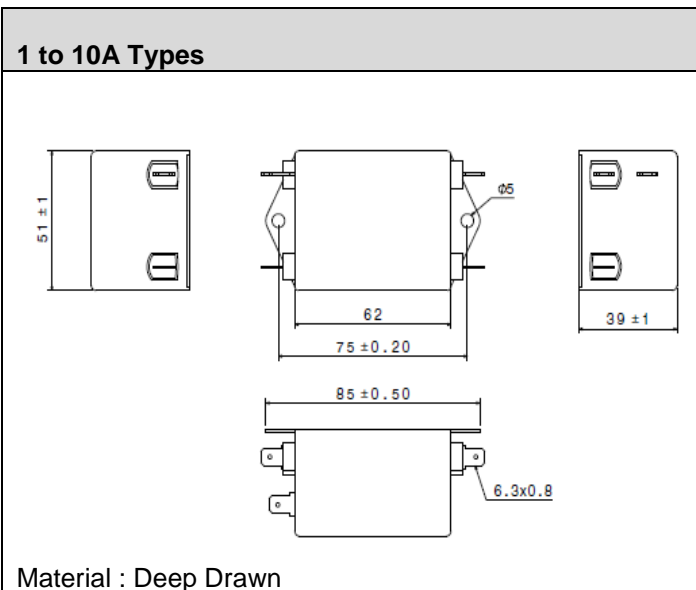

Thread Size	M5	M6
Recommended Torque (Nm)	2	2.5-3

All dimensions in mm; Tolerances according to ISO2768-m

Insertion Loss – (Common Mode)

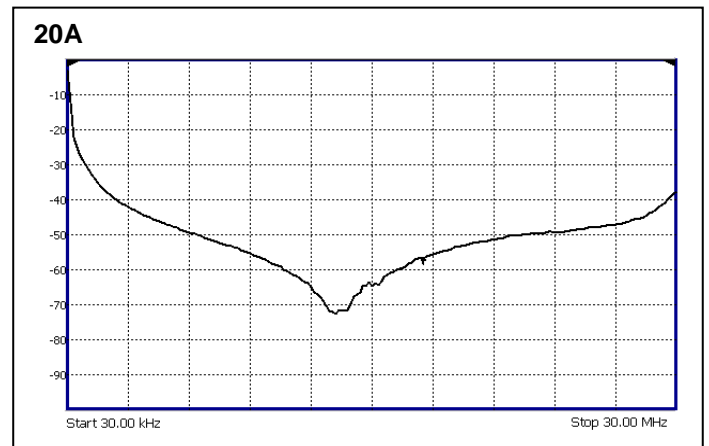
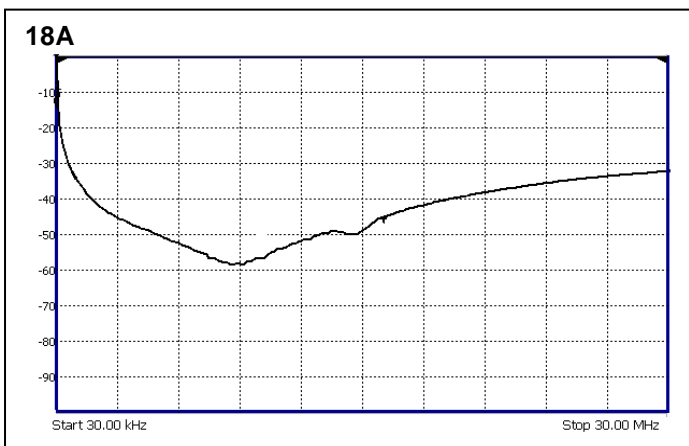
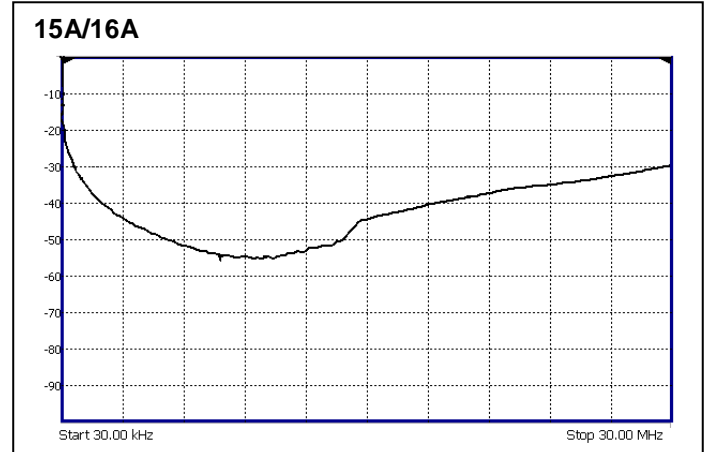
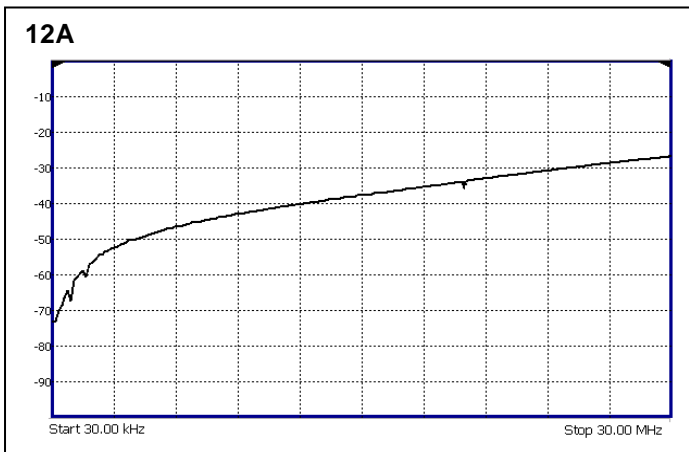
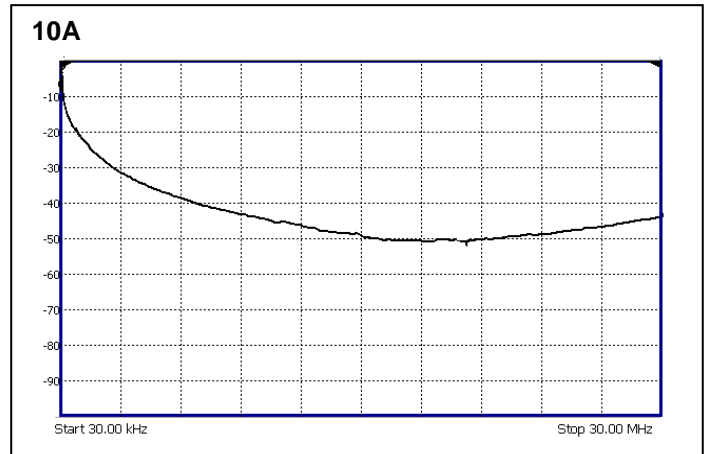
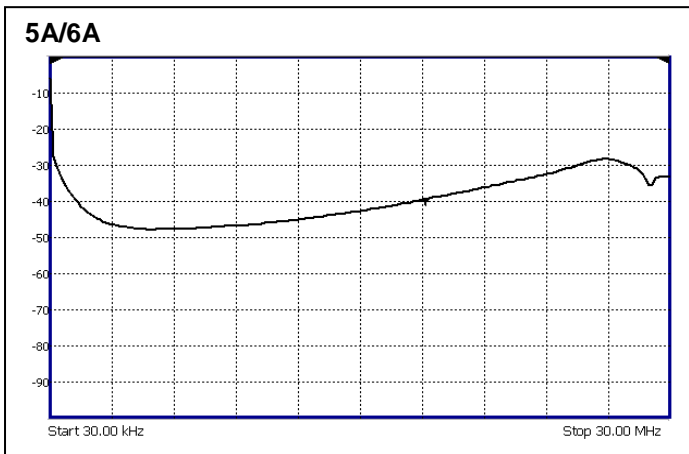
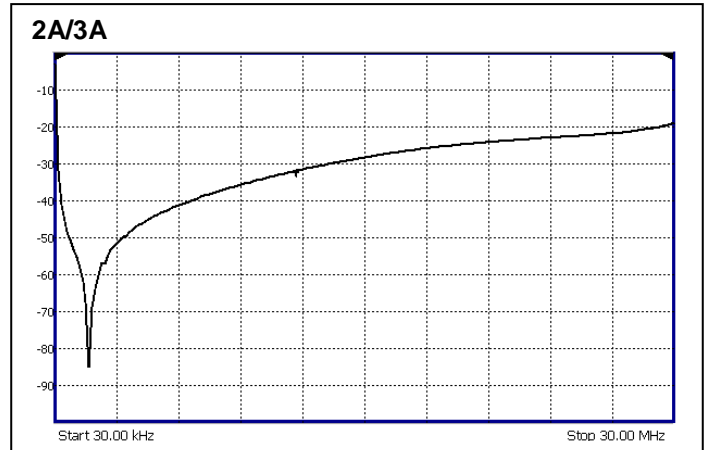
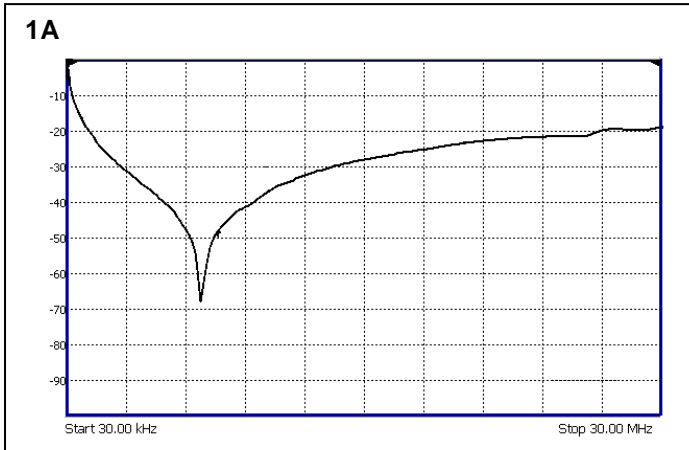

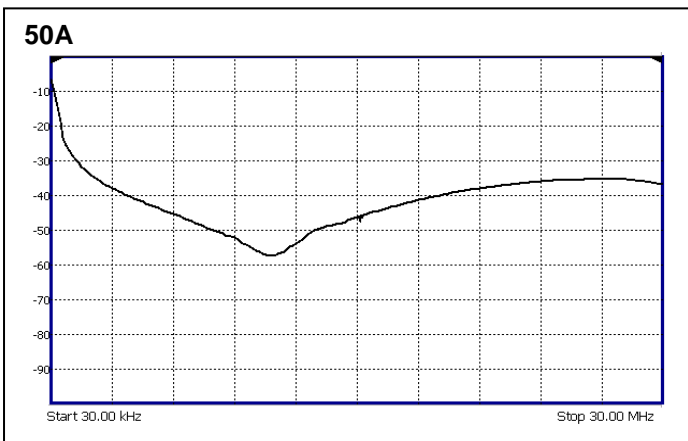
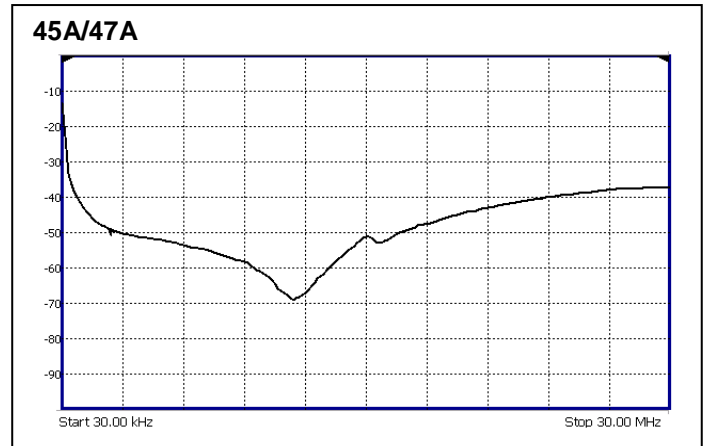
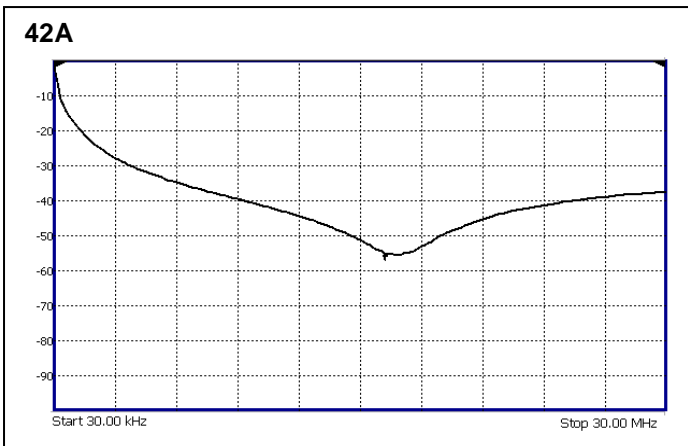
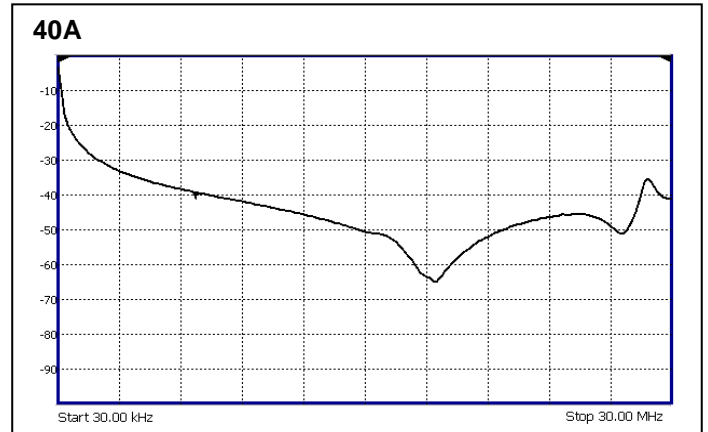
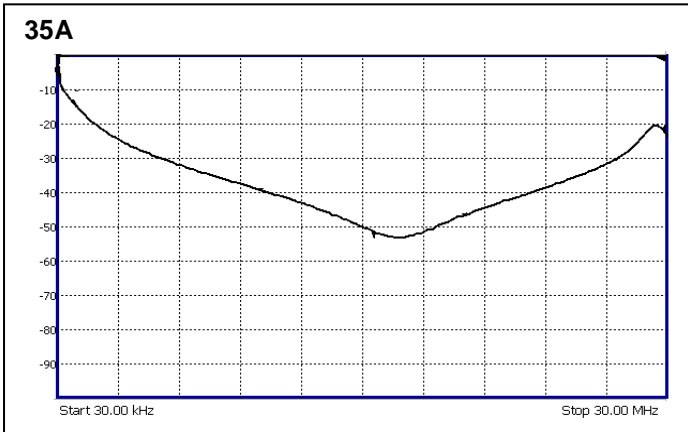
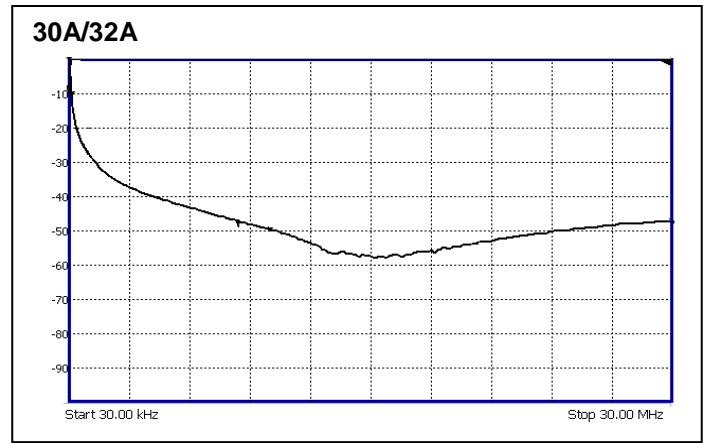
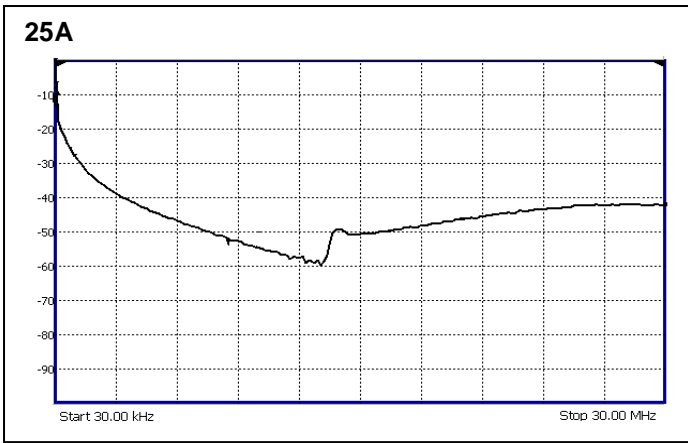

EMI Solutions Pvt Ltd
 #237-A5, Bommasandra Industrial Area, Bangalore-560099,
 Marketing: +91 80 27836880, Email: marketing@emisindia.com